

F4A-PDMDR-3M-X

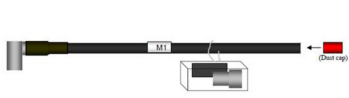

FSJ4-50B SureFlex® Jumper with interface types 7-16 DIN Male and 7-16 DIN Male Right Angle, 3 m

Product Classification

Product Type	SureFlex® standard
Product Brand	HELIAX® SureFlex®
Product Series	FSJ4-50B

General Specifications

Attachment, Connector B	Field attachment
Body Style, Connector A	Straight
Body Style, Connector B	Right angle
Interface, Connector A	7-16 DIN Male
Interface, Connector B	7-16 DIN Male
Specification Sheet Revision Level	A

Dimensions

Length	3 m 9.843 ft
Nominal Size	1/2 in

Electrical Specifications

DTF, Connector A	-32 dB
-------------------------	--------

VSWR/Return Loss

Frequency Band	VSWR, typical	Return Loss, typical (dB)
0–3000 MHz	1.106	25.96
2.2–2.7 GHz	1.083	27.99

Jumper Assembly Sample Label

F4A-PDMDR-3M-X



Environmental Specifications

Immersion Test Method Meets IEC 60529:2001, IP68 in mated condition

Regulatory Compliance/Certifications

Agency	Classification
ISO 9001:2015	Designed, manufactured and/or distributed under this quality management system

Included Products

- F4PDR-C – 7-16 DIN Male Right Angle for 1/2 in FSJ4-50B cable

F4PDR-C

7-16 DIN Male Right Angle for 1/2 in FSJ4-50B cable



Product Classification

Product Type	Wireless and radiating connector
Product Brand	HELIAX®

General Specifications

Body Style	Right angle
Cable Family	FSJ4-50B
Inner Contact Attachment Method	Captivated
Inner Contact Plating	Gold
Interface	7-16 DIN Male
Mounting Angle	Right angle
Outer Contact Attachment Method	Crush-flare
Outer Contact Plating	Trimetal
Pressurizable	No

Dimensions

Width	31.75 mm 1.25 in
Length	60.96 mm 2.4 in
Right Angle Length	45.72 mm 1.8 in
Diameter	40.39 mm 1.59 in
Nominal Size	1/2 in

Outline Drawing

F4PDR-C

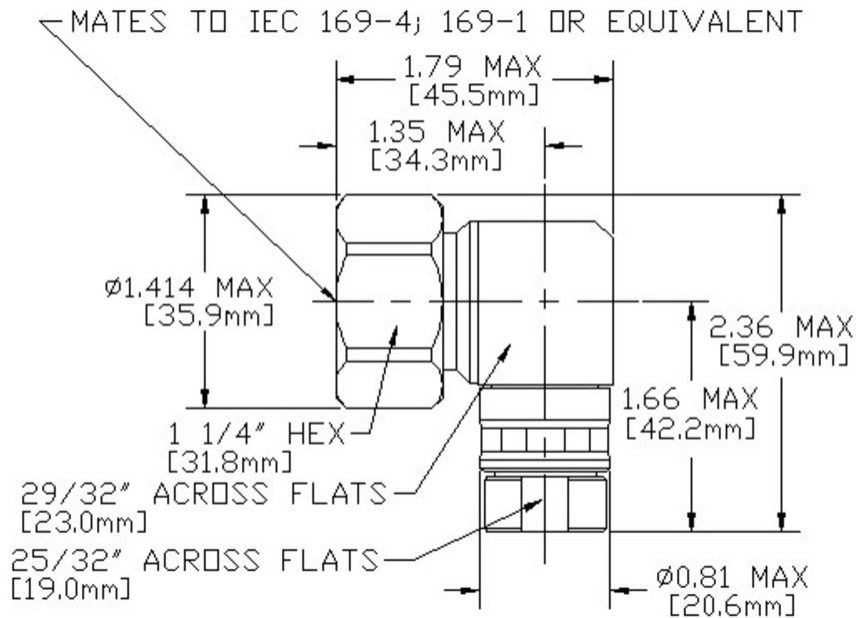

Electrical Specifications

3rd Order IMD at Frequency	-120 dBm @ 910 MHz
3rd Order IMD Test Method	Two +43 dBm carriers
Insertion Loss Coefficient, typical	0.05
Average Power at Frequency	1.0 kW @ 900 MHz
Cable Impedance	50 ohm
Connector Impedance	50 ohm
dc Test Voltage	2500 V
Inner Contact Resistance, maximum	0.8 mOhm
Insulation Resistance, minimum	5000 MOhm
Operating Frequency Band	0 – 5200 MHz
Outer Contact Resistance, maximum	1.5 mOhm
Peak Power, maximum	15.6 kW
RF Operating Voltage, maximum (vrms)	884 V
Shielding Effectiveness	-110 dB

VSWR/Return Loss

Frequency Band	VSWR	Return Loss (dB)
50–1000 MHz	1.04	34.16

F4PDR-C

1000–1900 MHz	1.04	34.16
1900–2200 MHz	1.07	29.42
2000–2700 MHz	1.1	26.45
2700–3600 MHz	1.13	24.29
3600–5000 MHz	1.25	19.09

Mechanical Specifications

Attachment Durability	25 cycles
Connector Retention Tensile Force	889.64 N 200 lbf
Connector Retention Torque	5.42 N-m 47.998 in lb
Coupling Nut Proof Torque	24.86 N-m 220.003 in lb
Coupling Nut Retention Force	1,000.85 N 225 lbf
Coupling Nut Retention Force Method	MIL-C-39012C-3.25, 4.6.22
Insertion Force	200.17 N 45 lbf
Insertion Force Method	IEC 61169-1:15.2.4
Interface Durability	500 cycles
Interface Durability Method	IEC 61169-4:9.5
Mechanical Shock Test Method	MIL-STD-202F, Method 213B, Test Condition C

Environmental Specifications

Operating Temperature	-55 °C to +85 °C (-67 °F to +185 °F)
Storage Temperature	-55 °C to +85 °C (-67 °F to +185 °F)
Attenuation, Ambient Temperature	20 °C 68 °F
Average Power, Ambient Temperature	40 °C 104 °F
Corrosion Test Method	MIL-STD-1344A, Method 1001.1, Test Condition A
Immersion Depth	1 m
Immersion Test Mating	Mated
Immersion Test Method	IEC 60529:2001, IP68
Moisture Resistance Test Method	MIL-STD-202F, Method 106F
Thermal Shock Test Method	MIL-STD-202, Method 107, Test Condition A-1, Low Temperature -55 °C
Vibration Test Method	IEC 60068-2-6
Water Jetting Test Mating	Mated
Water Jetting Test Method	IEC 60529:2001, IP66

F4PDR-C

Packaging and Weights

Weight, net 207.36 g | 0.457 lb

* Footnotes

Insertion Loss Coefficient, typical $0.05\sqrt{\text{freq}}$ (GHz) (not applicable for elliptical waveguide)

Immersion Depth Immersion at specified depth for 24 hours